

B48xxx-DB43

Nano SIM to Full Size SIM Extender

Product > Extender Board > B48xxx Series

B4814A-DB43

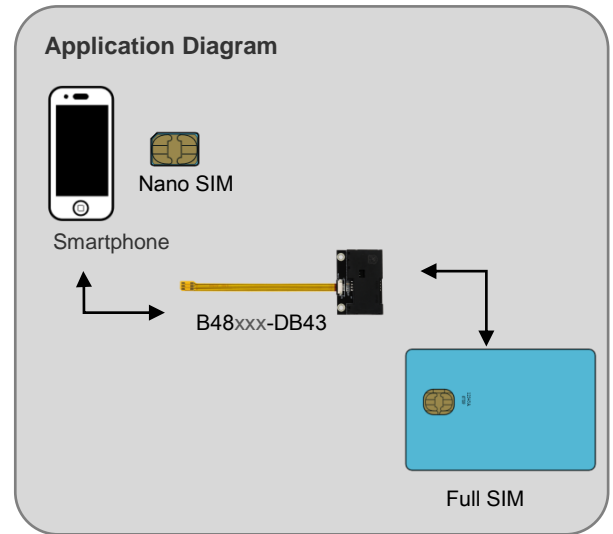
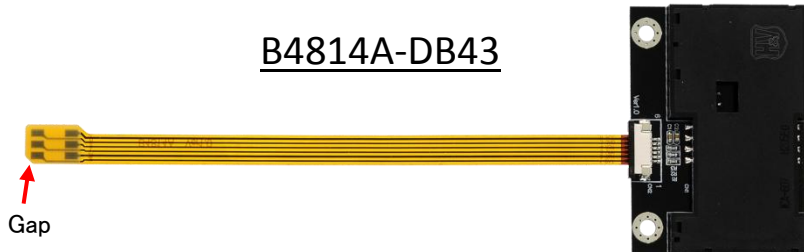

First Impression

B48xxx-DB43 Nano SIM to Full Size SIM card Extender is a debug and test tool. Design the FPC cable for flexible use.

It allows for full SIM Card to be extended from the host slot for Nano SIM interface. The especially designed is to save valuable labor and time in production environment.

SIM extender is designed to minimize the signal degradation effects of the extender by proven design techniques.

B48xxx-DB43 is a powerful tool for engineers and mobile phone nano SIM test protection.

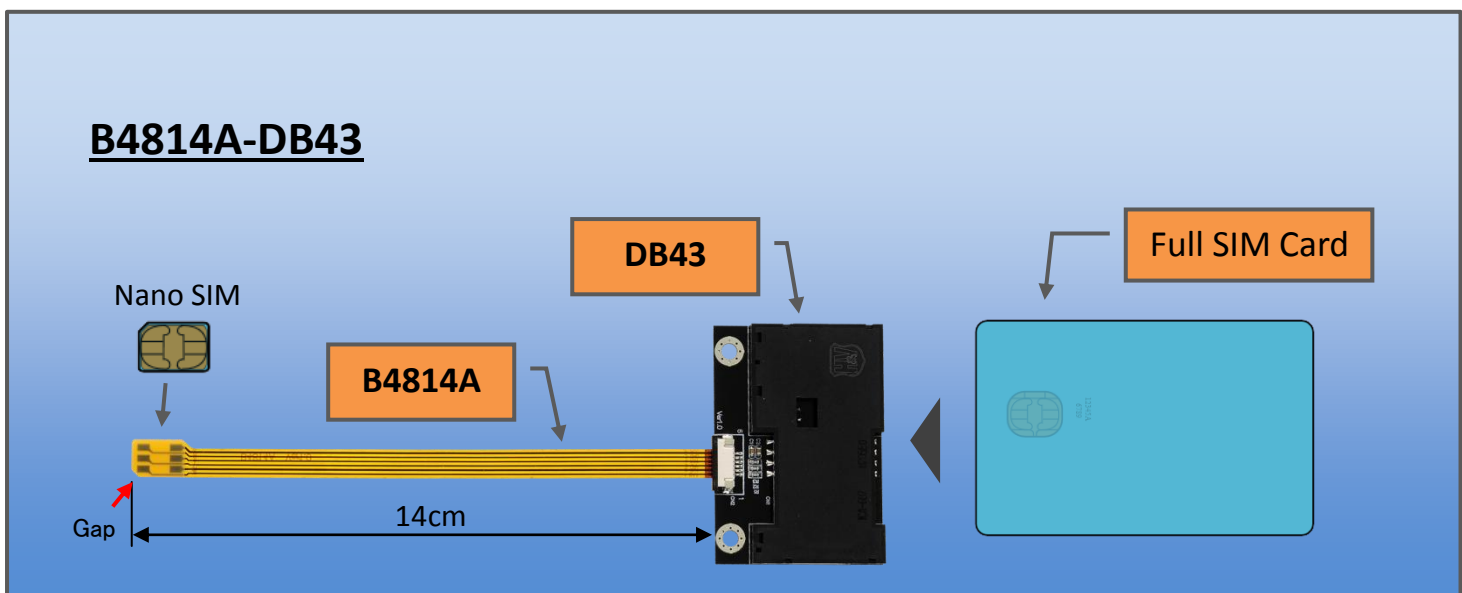

B32 / B40 / B43 / B44 / B45 / B46 / B48 series Comparison

B3214A-DB32



for iPhone5 / iPhone5S(c)
for NEW iPad / iPad-mini

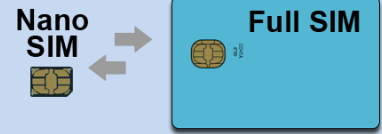

B4010A-DB43

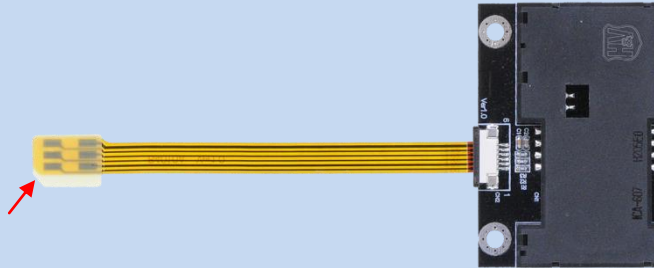

for Samsung Galaxy

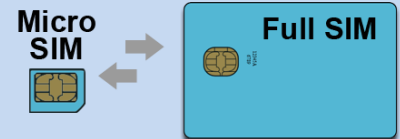

B4310A-DB43

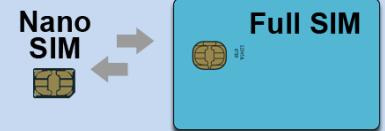
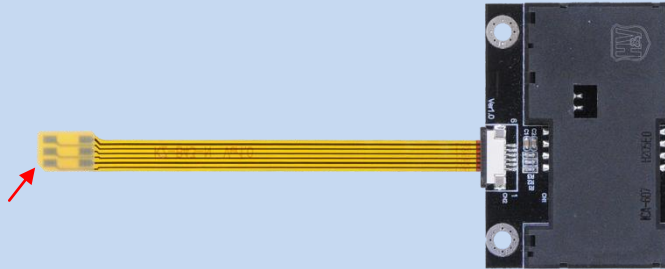



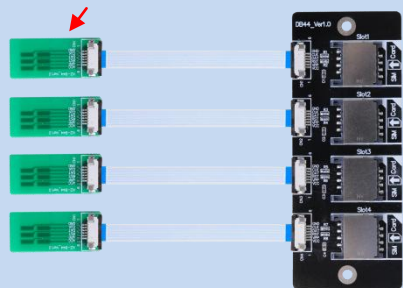

B4490A-DB44

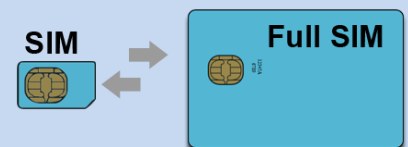

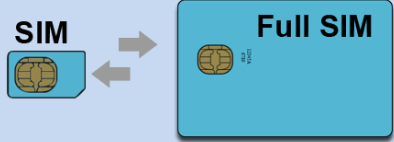
B4490A-DB32

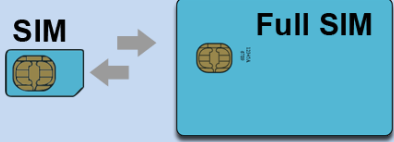
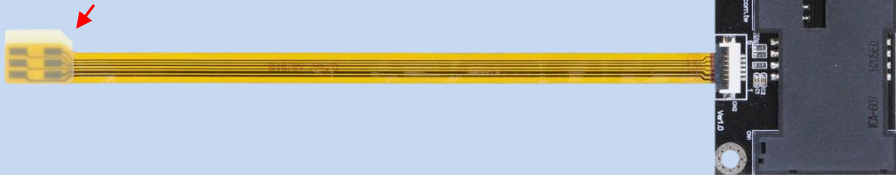

<p>B4490B-DB43</p> 	
<p>B4516A-DB43</p> 	
<p>B4616A-DB32</p> 	<p>For Apple iPhone4</p> 
<p>B4814A-DB43</p> 