

S5EX Smart Card Extender Ver1.0

Schematic update note:

First schematic.....2010/Aug/04

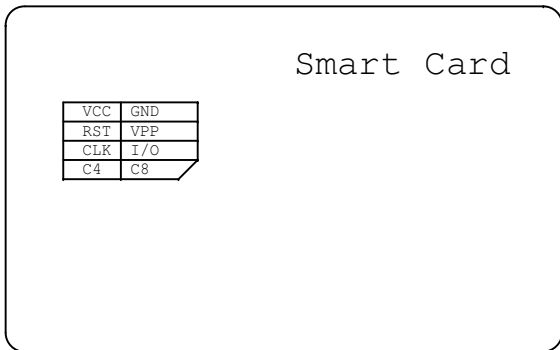
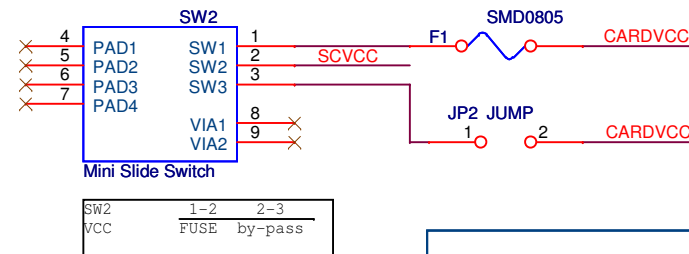
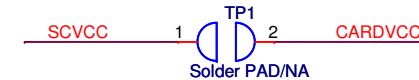
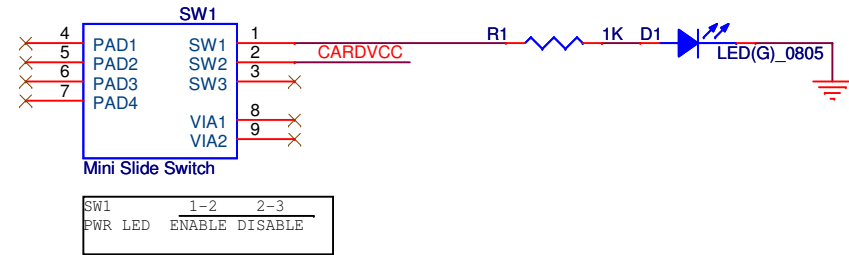
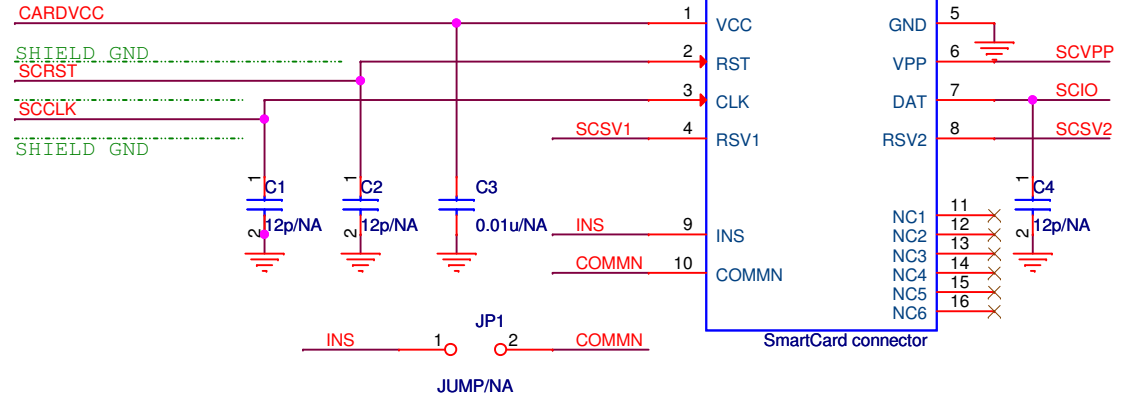
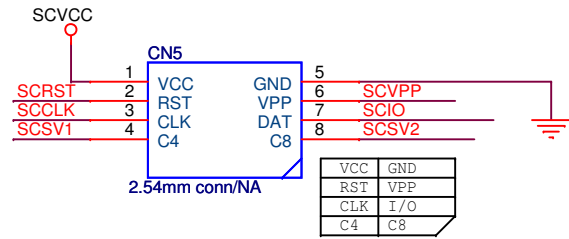
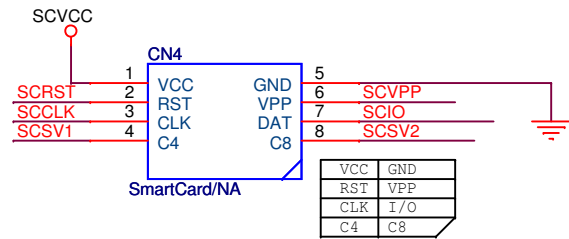
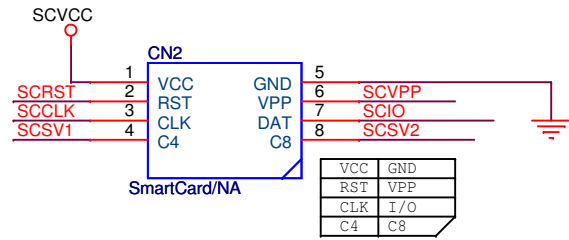

Title		Smart card Extender		Designer: Gerry Chen	
Size	A4	Document Number	S5EX	Bplus Technology Co., Ltd. www.bplus.com.tw	
Date:	Wednesday, August 11, 2010			Sheet	1 of 1
Rev	1.0				